

Categorical Semantics for Time Travel

Nicola Pinzani
University of Oxford
nicola.pinzani@cs.ox.ac.uk

Stefano Gogioso
University of Oxford
stefano.gogioso@cs.ox.ac.uk

Bob Coecke
University of Oxford
bob.coecke@cs.ox.ac.uk

We introduce a general categorical framework to reason about quantum theory and other process theories living in spacetimes where Closed Timelike Curves (CTCs) are available, allowing resources to travel back in time and provide computational speedups. Our framework is based on a weakening of the definition of traced symmetric monoidal categories, obtained by dropping the yanking axiom and the requirement that the trace be defined on all morphisms. We show that the two leading models for quantum theory with closed timelike curves—namely the P-CTC model of Lloyd et al. and the D-CTC model of Deutsch—are captured by our framework, and in doing so we provide the first compositional description of the D-CTC model. Our description of the D-CTC model results in a process theory which respects the constraints of relativistic causality: this is in direct contrast to the P-CTC model, where CTCs are implemented by a trace and allow post-selection to be performed deterministically.

(Extended abstract for [16], accepted for presentation at LICS 2019)

The possibility of traveling back in time, and the many paradoxes associated with its more practical formulations, have fascinated humans for centuries, and the development of Relativity provided a solid mathematical foundation to the concept in the form of Closed Timelike Curves (CTCs) [4, 10, 11, 15]. In the context of quantum computer science, the possibility of time travel acquires a special significance, because models of quantum processes in the presence of CTCs—such as the *P-CTC model* of Lloyd et al. [13, 14] and the *D-CTC model* of Deutsch [9]—display large computational speedups [1, 2].

This work fits within the broader framework of *process theories* (aka symmetric monoidal categories) and *categorical quantum mechanics* [3, 7, 17]. More specifically, it is part of recent efforts to understand the complex interplay between quantum theory and Relativistic causal structure, initiated by [6, 8] and recently brought into the spotlight by the work of [12]. Here, we push the envelope and give a rigorous process-theoretic treatment of chronology-violating causal scenarios, including the only compositional presentation for the D-CTC model to date. Chronology-violating scenarios are of great foundational and computational interest, but they are also easy to misunderstand and riddled with paradoxes: the development of sound categorical semantics brings general reasoning about them back on firm ground.

The main inspiration for this work comes from the contrast between the P-CTC model—where time-travel is equivalent to post-selection [5] and involves traced monoidal structure—and the D-CTC model. In the D-CTC model, single-system processes take the following form, where Φ is a CPTP map:

$$\begin{array}{c} \mathcal{H} \\ | \\ \text{---} \\ | \\ \boxed{\Phi} \\ | \\ \text{---} \\ | \\ \mathcal{H} \end{array} \begin{array}{c} \text{---} \\ | \\ \mathcal{C} \\ | \\ \text{---} \\ | \\ \mathcal{C} \\ | \\ \text{---} \end{array} \quad (1)$$

The markings on the right denote that the state on quantum system \mathcal{C} emerges from the CTC in the immediate past of the interaction, and re-enters the CTC in its immediate future, never to be accessed

again. Deutsch defines the single-system behavior of an interaction with CTCs as a function mapping normalized quantum states on \mathcal{H} to normalized quantum states on \mathcal{H} : this function involves a fixed-point equation, resulting in non-linear and discontinuous behavior. Further than that, it actually results in entanglement-breaking behavior.

$$\frac{1}{2} \left(\text{Diagram 1} \right) \neq \frac{1}{2} \left(\text{Diagram 2} \right)$$

In particular, this implies that the D-CTC model fails to be locally process tomographic, and that time travel within it cannot be modeled using traced monoidal categories.

When talking about causal scenarios in process theories, one is really combining two distinct ingredients: (i) a causal graph, representing the events in the scenario and the causal relationship between them; and (ii) a map assigning each event in the scenario to the process happening there. In the usual chronology-respecting (CR) scenarios, where causal graphs are (non-transitive) directed acyclic graphs, the combination of these two ingredients does not pose much of a challenge: a process is associated to each event and outputs/inputs of the process are connected by wires following the edges of the graph.

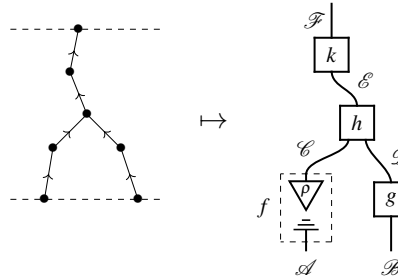

In scenarios involving chronology-violating (CV) regions, however, there is a problem: no prescription exists in a generic symmetric monoidal category for what it means to connect processes in a cycle. In the P-CTC model, where traced monoidal structure is available, cycles can be created easily.

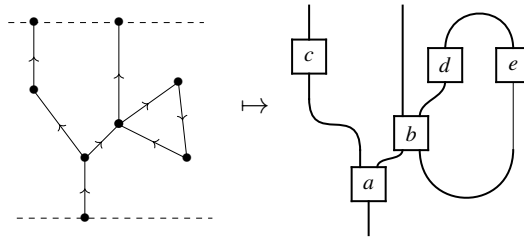

In the D-CTC model, on the other hand, traced monoidal structure is not available, and we have to develop a more general approach. We observe that causal graphs with cycles can be transformed into ordinary causal graphs by “cutting the cycles open”:

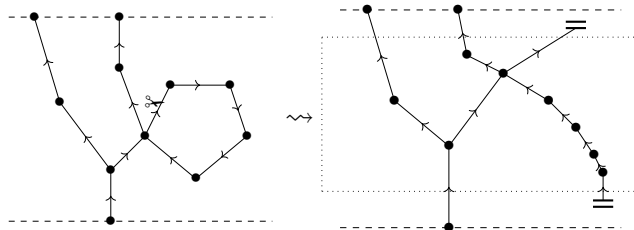

This means that we can decompose the task of drawing diagrams over causal graphs involving CV regions into two distinct parts: drawing diagrams over CR graphs, which we already know how to do, and finding a way to glue the cut ends of the cycles back together at the end. The latter part will be carried out by a “time-travel super-operator”, taking a pair of input/output wires and “applying a CTC” to them.

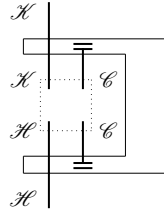

Because there is no one canonical place to cut cycles open at, such a “time-travel super-operator” will have to satisfy a certain “sliding property”, to ensure that all ways of cutting a cycle open will lead to the same diagram in the end (see Figure 1).

Definition. A process theory with time travel is a symmetric monoidal category \mathcal{C} together with a time-traveling super-operator, satisfying the following properties and mapping morphisms of \mathcal{C} to morphisms in a larger symmetric monoidal category \mathcal{D} (within which \mathcal{C} is faithfully embedded).

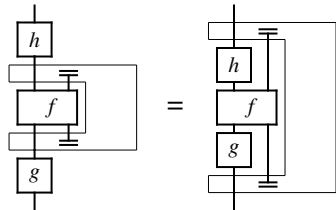

Naturality

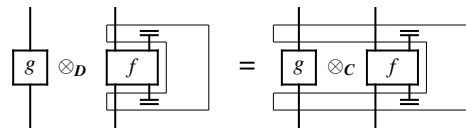

Strength

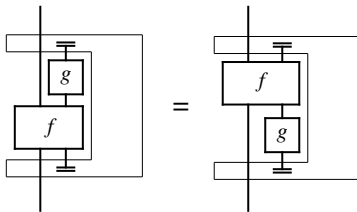

Sliding

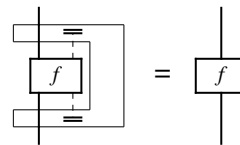

Vanishing (dashed = tensor unit)

Theorem. The P-CTC model and the D-CTC model are both process theories with time travel.

Theorem. In a process theory with time travel, diagrams over causal graphs involving local interactions with CTCs are always well-defined.

Though the properties of time-travel super-operators closely resembles those defining traces in traced monoidal categories, the following *yanking property* for traces is not required to hold for time-travel super-operators:

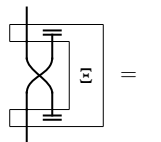

This allows our framework to capture examples, such as the D-CTC model, in which the map on the left may act as the identity on a single system but have more subtle behavior on composite systems.

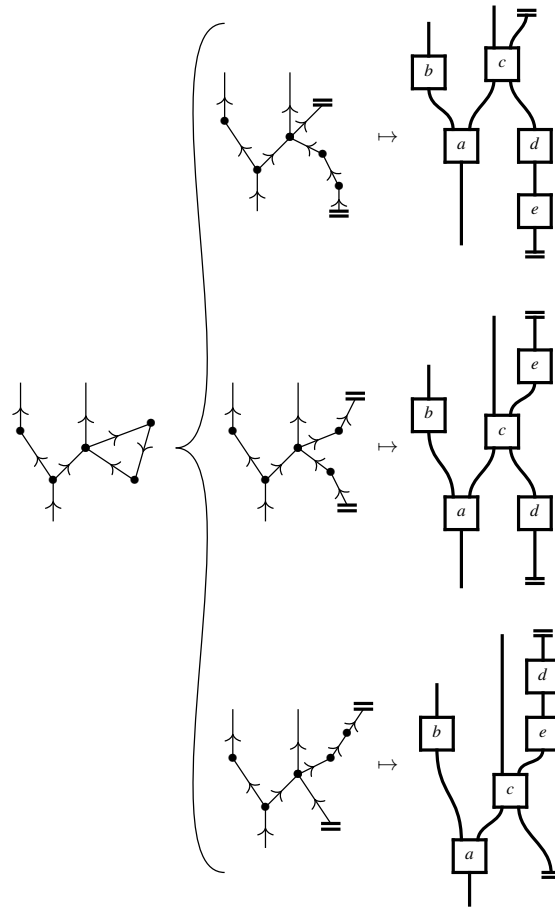

Figure 1: The definition of a time-travel super-operator must satisfy the sliding property, to ensure that the diagrams obtained by cutting open a cycle in all possible ways all correspond to the same morphism in the end.

References

- [1] S. Aaronson (2005): *Quantum computing, postselection, and probabilistic polynomial-time*. *Proceedings of the Royal Society A* 461, pp. 3473–3482, doi:10.1098/rspa.2005.1546. Available at <https://dx.doi.org/10.1098/rspa.2005.1546>.
- [2] S. Aaronson & J. Watrous (2009): *Closed timelike curves make quantum and classical computing equivalent*. *Proceedings of the Royal Society A* 465, p. 631, doi:10.1098/rspa.2008.0350. Available at <https://dx.doi.org/10.1098/rspa.2008.0350>.
- [3] S. Abramsky & B. Coecke (2009): *Categorical Quantum Mechanics*. In K. Engesser, Gabbay D. M. & Lehmann D., editors: *Handbook of Quantum Logic and Quantum Structures*, Elsevier, pp. 261–323, doi:10.1016/B978-0-444-52869-8.50010-4. Available at <https://dx.doi.org/10.1016/B978-0-444-52869-8.50010-4>.
- [4] W. B. Bonnor (1980): *The rigidly rotating relativistic dust cylinder*. *Journal of Physics A* 13, pp. 2121–2132, doi:10.1088/0305-4470/13/6/033. Available at <https://dx.doi.org/10.1088/0305-4470/13/6/033>.
- [5] T. A. Brun & M. M. Wilde (2012): *Perfect State Distinguishability and Computational Speedups with Postselected Closed Timelike Curves*. *Foundations of Physics* 42, p. 341, doi:10.1007/s10701-011-9601-0. Available at <https://doi.org/10.1007/s10701-011-9601-0>.
- [6] B. Coecke (2016): *Terminality Implies No-signalling ...and Much More Than That*. *New Generation Computing* 34(1), pp. 69–85, doi:10.1007/s00354-016-0201-6. Available at <https://doi.org/10.1007/s00354-016-0201-6>.
- [7] B. Coecke & A. Kissinger (2017): *Picturing Quantum Processes: A First Course in Quantum Theory and Diagrammatic Reasoning*. Cambridge University Press, doi:10.1017/9781316219317. Available at <https://dx.doi.org/10.1017/9781316219317>.
- [8] B. Coecke & R. Lal (2013): *Causal categories: relativistically interacting processes*. *Foundations of Physics* 43, pp. 458–501, doi:10.1007/s10701-012-9646-8. Available at <https://dx.doi.org/10.1007/s10701-012-9646-8>.
- [9] D. Deutsch (1991): *Quantum mechanics near closed timelike lines*. *Physical review. D* 44(10), p. 3197–3217, doi:10.1103/physrevd.44.3197. Available at <https://dx.doi.org/10.1103/physrevd.44.3197>.
- [10] K. Gödel (1949): *An Example of a New Type of Cosmological Solution of Einstein's Field Equations of Gravitation*. *Reviews of Modern Physics* 21, pp. 447–450, doi:10.1023/A:1001959224682. Available at <https://dx.doi.org/10.1023/A:1001959224682>.
- [11] R. P. Kerr (1963): *Gravitational Field of a Spinning Mass as an Example of Algebraically Special Metrics*. *Phys. Rev. Lett.* 11, pp. 237–238, doi:10.1103/PhysRevLett.11.237. Available at <https://dx.doi.org/10.1103/PhysRevLett.11.237>.
- [12] A. Kissinger & S. Uijlen (2017): *A categorical semantics for causal structure*. *Logic in Computer Science (LICS), 32nd Annual ACM/IEEE Symposium on*, doi:10.1109/LICS.2017.8005095. Available at <https://dx.doi.org/10.1109/LICS.2017.8005095>.
- [13] S. Lloyd, L. Maccone, R. Garcia-Patron, V. Giovannetti & Y. Shikano (2011): *Quantum mechanics of time travel through post-selected teleportation*. *Physical Review D* 84, p. 025007, doi:10.1103/PhysRevD.84.025007. Available at <https://dx.doi.org/10.1103/PhysRevD.84.025007>.
- [14] S. Lloyd, L. Maccone, R. Garcia-Patron, V. Giovannetti, Y. Shikano, S. Pirandola, L. A. Rozema, A. Darabi, Y. Soudagar, L. K. Shalm & A. M. Steinberg (2011): *Closed Timelike Curves via Postselection: Theory and Experimental Test of Consistency*. *Phys. Rev. Lett.* 106, p. 040403, doi:10.1103/PhysRevLett.106.040403. Available at <https://dx.doi.org/10.1103/PhysRevLett.106.040403>.
- [15] C. W. Misner (1965): *Taub-NUT space as countermeasure to almost anything*. Technical Report NASA-CR-70033, NASA. Available at <https://ntrs.nasa.gov/search.jsp?R=19660007407>.

- [16] N. Pinzani, S. Gogioso & B. Coecke (2019): *Categorical Semantics for Time Travel*. *Logic in Computer Science (LICS), 34th Annual ACM/IEEE Symposium on*. Available at <https://arxiv.org/abs/1902.00032>.
- [17] P. Selinger (2011): *A Survey of Graphical Languages for Monoidal Categories*. In Bob Coecke, editor: *New Structures for Physics, Lecture Notes in Physics* 813, Springer, pp. 289–355, doi:10.1007/978-3-642-12821-9_4. Available at https://dx.doi.org/10.1007/978-3-642-12821-9_4.